

JOHN E. MOORE.

Improvement in Bee Hives.

No. 123,924.

Patented Feb. 20, 1872.

Fig. 1.

Fig. 2.

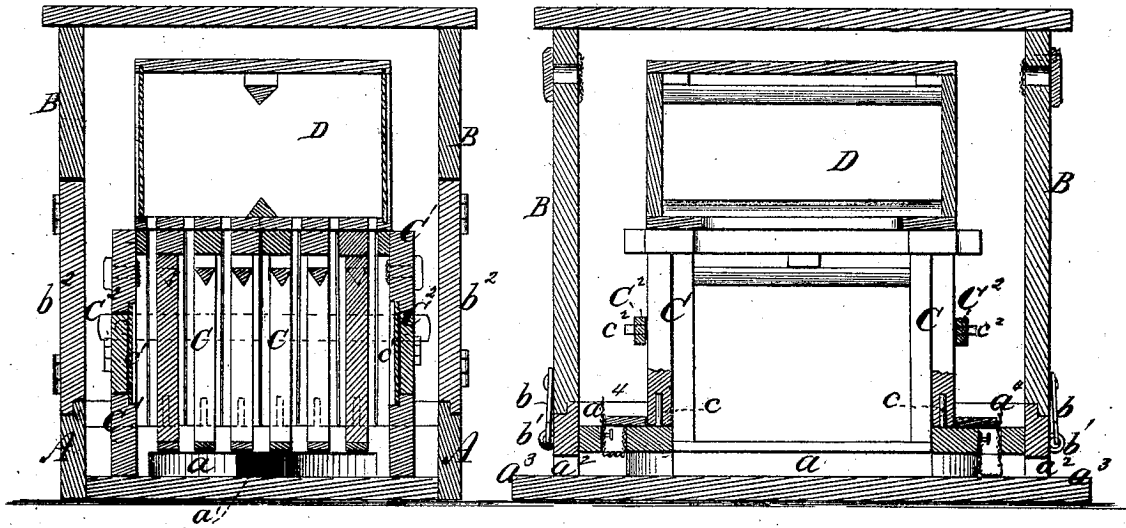

Fig. 3.

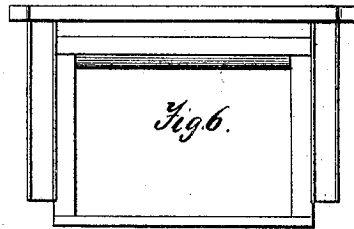
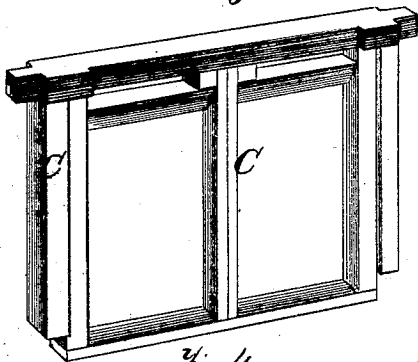

Fig. 6.

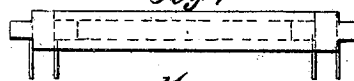

Fig. 7.

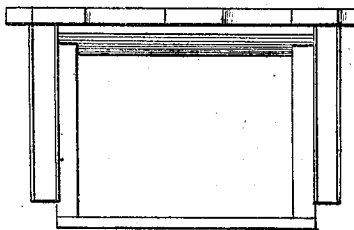

Fig. 8.



Fig. 9.

Fig. 4.

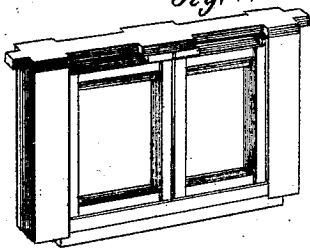

Fig. 5.

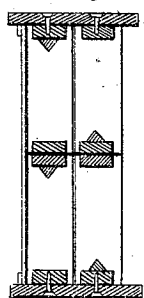

Fig. 10.



Witnesses.

A. Ruppert.  
J. William Moore

Inventor.

John E. Moore  
Edson A. Root  
Attorney

JOHN E. MOORE.

Improvement in Bee Hives.

No. 123,924.

Patented Feb. 20, 1872.

Fig. 1.

Fig. 2.

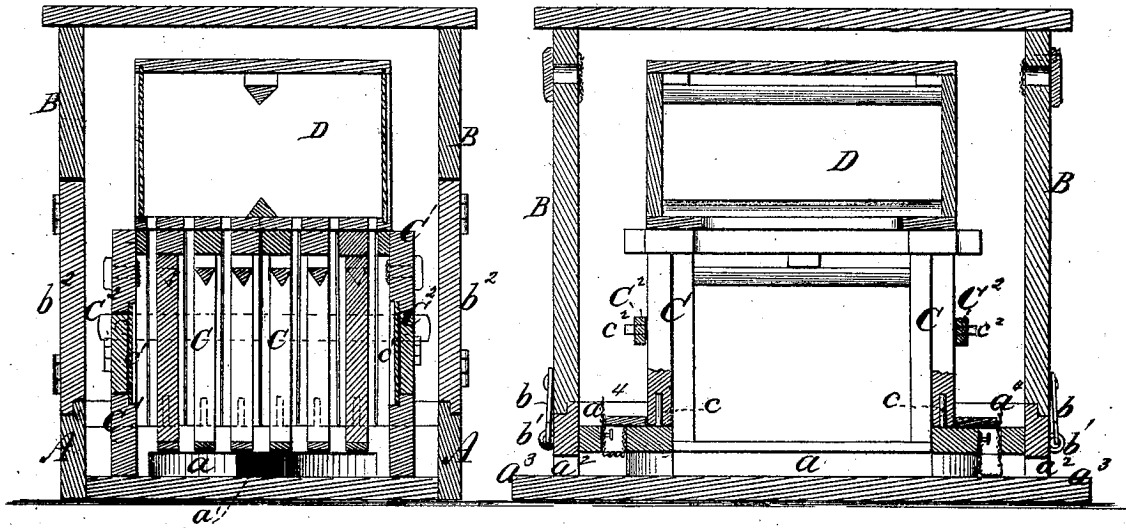

Fig. 3.

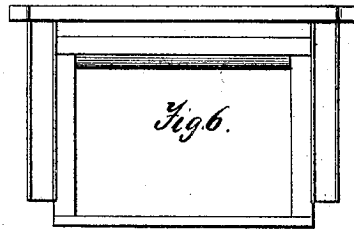
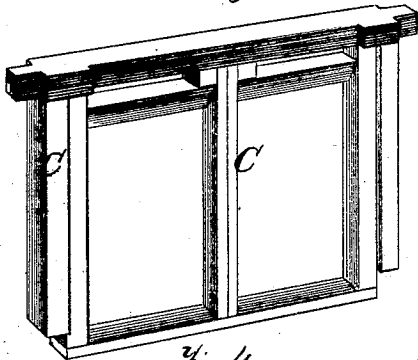

Fig. 7.

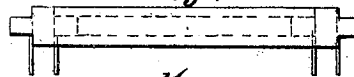

Fig. 8.

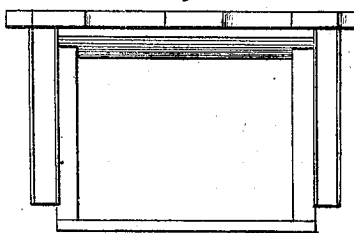

Fig. 9.

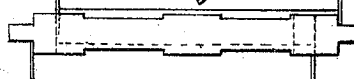

Fig. 4.

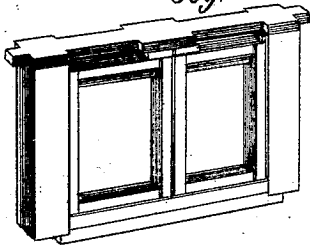

Fig. 5.

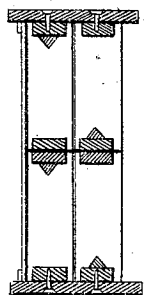

Fig. 10.



Witnesses.  
A. Ruppert.  
J. William Moore

Inventor.  
John E. Moore  
Edson A. Root  
Attorney