

(No Model.)

2 Sheets—Sheet 1.

# R. C. AIKIN & H. KNIGHT. BEEHIVE.

No. 522,772.

Patented July 10, 1894.

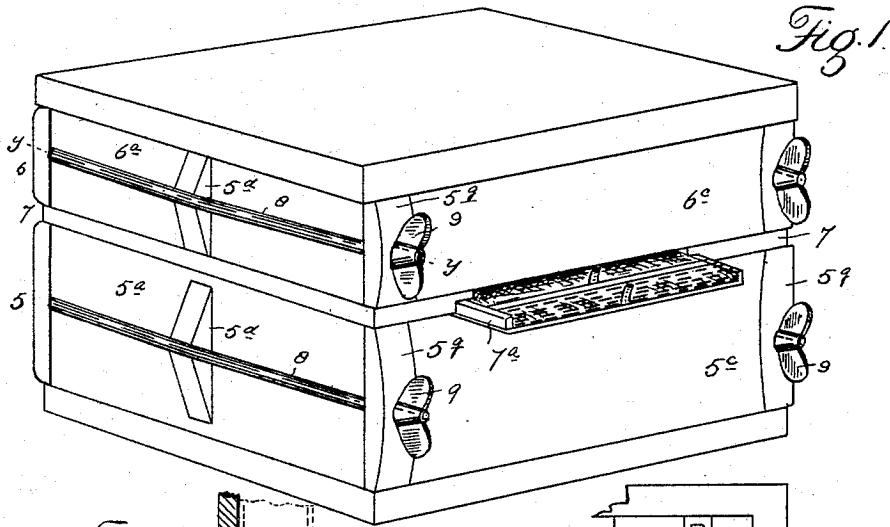

Fig. 1.

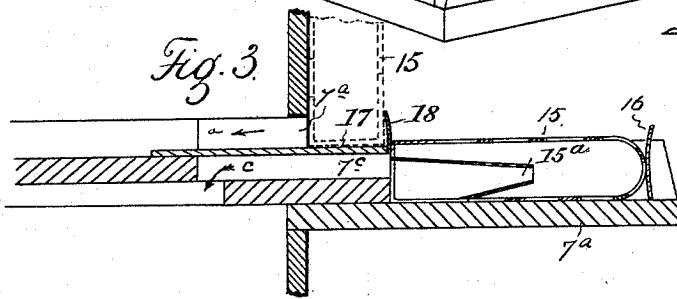

Fig. 3.

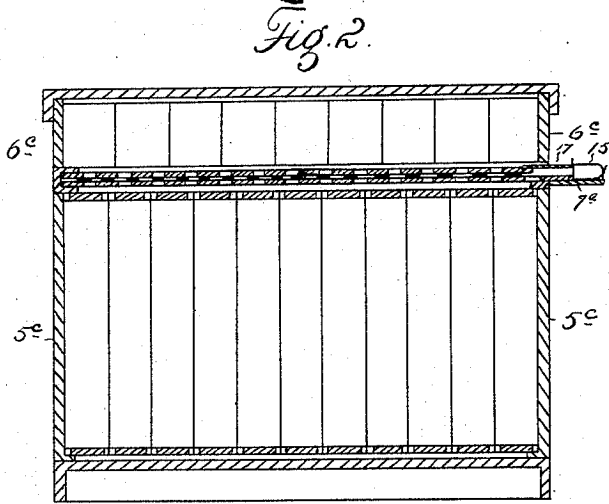

Fig. 2.

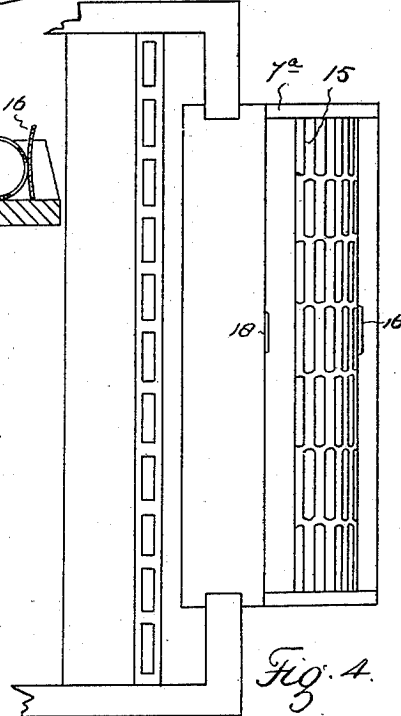

Fig. 4.

WITNESSES:

*G. J. O'Connell*  
*Wm. McConnell*

INVENTORS  
*Robert Aikin*  
*Henry Knight*  
 BY  
*A. J. Mein*  
 ATTORNEY.

(No Model.)

2 Sheets—Sheet 2.

# R. C. AIKIN & H. KNIGHT. BEEHIVE.

No. 522,772.

Patented July 10, 1894.

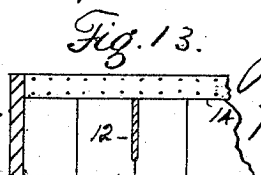
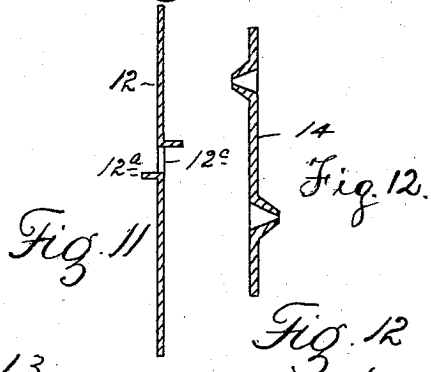
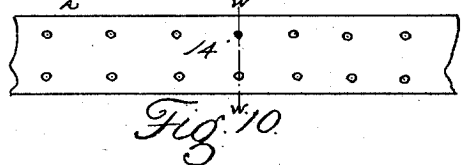
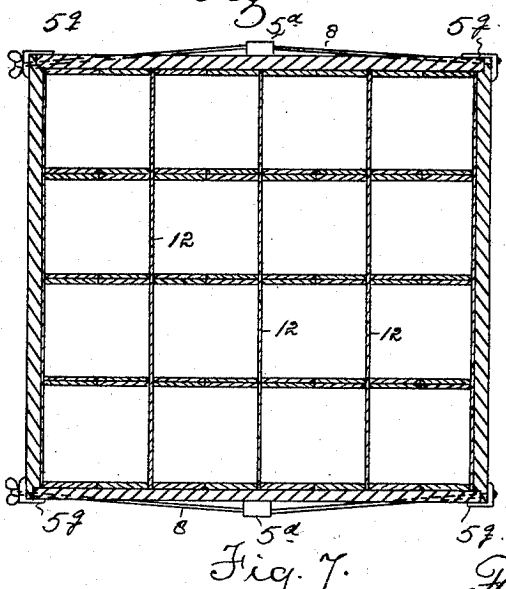
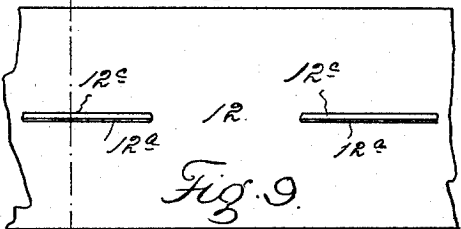
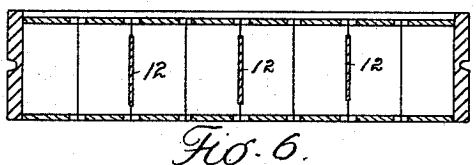
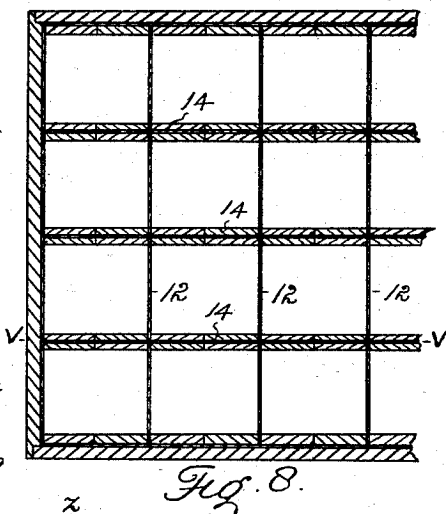
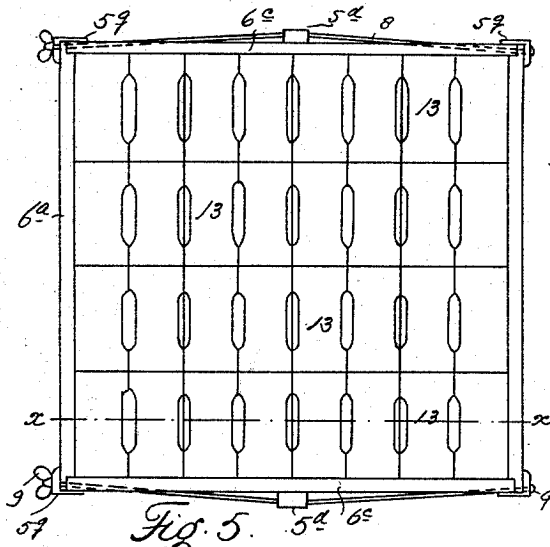

WITNESSES:  
*G. J. Dillman*  
*Wm. McConnell*

INVENTORS  
*R. C. Aikin*  
*Harry Knight*  
 BY  
*A. J. Mein*  
 ATTORNEY.

# UNITED STATES PATENT OFFICE.

ROBERT C. AIKIN, OF LOVELAND, AND HARRY KNIGHT, OF LITTLETON,  
COLORADO.

## BEEHIVE.

SPECIFICATION forming part of Letters Patent No. 522,772, dated July 10, 1894.

Application filed January 31, 1893. Serial No. 460,478. (No model.)

*To all whom it may concern:*

Be it known that we, ROBERT C. AIKIN, residing at Loveland, county of Larimer, and HARRY KNIGHT, residing at Littleton, county of Arapahoe, State of Colorado, both citizens of the United States of America, have invented certain new and useful Improvements in Beehives; and we do declare the following to be a full, clear, and exact description of the invention, such as will enable others skilled in the art to which it appertains to make and use the same, reference being had to the accompanying drawings, and to the figures of reference marked thereon, which form a part of this specification.

Our invention relates to improvements in bee-hives and our object is to overcome the defects in hives as heretofore constructed, and to this end our invention concerns the three parts of the hive, namely, the brood chamber, the honey board, and the super as hereinafter described.

The casing both of our improved brood chamber and the super is held together by tension rods when in use, thus permitting these parts to be shipped in "knock down" shape and greatly lessening the cost of transportation. The tension of the rods is regulated by thumb nuts applied to their projecting threaded extremities, thus making it a very easy matter to assemble the parts and adjust the casing, which by the use of the thumb nuts, may be drawn together and the inner frames or sections compressed as tightly as desired.

Another very important feature of our invention relates to the manner of supporting the sections in the super. Heretofore these sections have been supported from the bottom which engaged or rested upon the supporting means. The most common and perhaps the best means heretofore employed to accomplish this purpose consists of what is known to apiarists and hive manufacturers as T-tins. When in place the cross section of this means of support is T-shaped with the T inverted, the leg of which extends upward between the sections while the bottoms of the adjacent sections engage the projections or flanges on each side of the leg. These T-tins are formed from an integral

piece of sheet metal, thus making the leg double; moreover, its two parts are never pressed close together but are somewhat separated whereby this T-tin support for the sections keeps them considerably separated and open at the top, allowing the bees access for the deposition of propolis between the sections. This propolis deposit is very objectionable for several reasons well understood by apiarists and those skilled in bee culture. Hence it is desirable that these sections should be brought together as closely as possible, whereby access to the bees is prevented. Moreover when the sections are supported by T-tins they are liable to get out of shape, since from their construction they have a tendency to approach the diamond-shape, which the T-tin permits as it gives support only from the bottom. We overcome this difficulty by providing the separators lying between the sections with short spurs of any desired shape, which are adapted to indent the edges of the sections and embed themselves therein as the sections are compressed by the tension rods, whereby the sections are brought very closely together, since the separators are composed of a single strip of very thin sheet metal. Instead of providing the separators with spurs, auxiliary separating strips provided with spurs may be employed. These are dropped in between the sections above the ordinary separators and at right angles thereto.

The invention consists further of the features, arrangements and combinations hereinafter described and claimed, and the entire construction in all its details will be fully understood by reference to the accompanying drawings in which is illustrated an embodiment of the invention.

In the drawings, Figure 1 is a perspective view of the complete hive embodying our improved features. Fig. 2 is a vertical section taken through the same. Fig. 3 is a fragmentary vertical section taken through the front part of the honey board, which is shown on a larger scale. Fig. 4 is a top or plan view of the same. Fig. 5 is a top or plan view of the super. Fig. 6 is a vertical section of the same taken on the line  $x-x$ , Fig. 5. Fig. 7 is a horizontal section taken through the

super on the line  $y-y$ , Fig. 1. Fig. 8 is a similar section partially broken away and showing the auxiliary spur supports in place. Fig. 9 is a detail plan view of the separator provided with the supporting spurs. Fig. 10 is a similar view of the auxiliary strip provided with the supporting spurs. Fig. 11 is a vertical section taken on line  $z-z$ , Fig. 9. Fig. 12 is a similar section taken on the line  $w-w$ , Fig. 10, but shown on an enlarged scale. Fig. 13 is a section taken on the line  $v-v$ , Fig. 8.

Similar reference characters indicating corresponding parts or elements of the mechanism in the several views let the numeral 5 designate the brood chamber, 6 the super and 7 the honey board. The brood chamber casing is composed of four parts or sides, two of which designated as  $5^a$  (only one being shown) are provided with grooved projections  $5^d$  adapted to receive the tension rods 8 which pass through the apertured extremities of the other two sides  $5^c$ , and are secured by thumb nuts 9, which the extremities of the rods are threaded to receive, their opposite extremities being provided with suitable heads. The apertured extremities  $5^c$  of the sides are provided with metal corner plates  $5^b$  which form bearing surfaces for the heads and nuts of the tension rods. These plates give firmness, durability and strength to the hive.

The sides  $5^a$  of the brood chamber are grooved to receive the rods 8, the grooves being at the extremities of the sides. The rods thus bend outwardly from their extremities to their engagement with the projections  $5^d$ . Hence as the thumb nuts are properly turned the casing is compressed both in the direction of the rods extension and at right angles thereto.

The sides  $6^a$  and  $6^c$  forming the super casing are connected, regulated and adjusted in precisely the same manner as the corresponding or similar parts of the brood-chamber just described, hence the tension rods, thumb nuts, corner plates and grooved projections will be designated by the same reference characters.

The super is provided with the separators 12 having the spurs  $12^a$  projecting in opposite directions from their two surfaces and adapted to indent the edges of the sections 13 which they engage. As shown in the drawings these spurs are formed by cutting a slit  $12^c$  in those parts of the separator engaging the sides of each two contiguous sections, and then turning the edges of the material outwardly in opposite directions and at right angles to the body of the separator. This is a very simple method of forming the short spurs which as the sides of the super are compressed by the use of the tension rods, readily enter the edges of the sections and embed themselves in such a manner that the separator surfaces are brought to actual engagement with the sections and as closely as would be the case if the spurs were not employed. These indenting spurs or edges are located about mid-

way of the vertical extension of the separator and therefore support the sections firmly in place and permit of their being brought closely together whereby the bees are prevented from depositing propolis between them as before explained. Or the separators may be made plain and auxiliary spur-strips 14 employed which are dropped in between the sections at right angles to the separators and above the same as shown in the drawings. The spurs on the auxiliary supporting strips 14 are formed by perforating the strips from opposite sides, causing the edges around the apertures to project in opposite directions on the two surfaces.

The honey board 7 is of ordinary construction except that it affords the passage way for the ingress and egress of the bees. Hence it carries the alighting board  $7^a$  which is fashioned to receive the queen and drone trap 15. The honey board is provided with the entrance  $7^a$  in front through which the work bees pass directly into and from the super without entering the brood chamber. In consequence of this arrangement it is believed the bees will deposit a greater amount of honey in the super than in those hives where they are obliged to pass through the brood-chamber before entering the super. The honey board is also provided with the passage way  $7^c$  leading to and from the brood chamber. These passage ways are further designated by the arrows  $a$  and  $c$ .

The ordinary position of the trap 15 is shown in Fig. 3, the same being held in place by the spring projection 16. This trap is a perforated metal receptacle whose perforations are large enough to allow the work bees to pass in and out at will. It is provided with a metal cone  $15^a$  suitably attached therein and surrounding the passage leading from the brood chamber. The cone is of such construction that while it allows the queen bee to pass from the brood chamber into the trap, it prevents her return to the chamber. Hence the term trap as applied to the device in question. The object of the queen trap is to catch the queen when a swarm issues from the hive. The bees will then return to find their queen, when they may be hived in the usual way. The trap is removed from the position on the alighting board and placed edgewise against the super to allow the queen to take her "wedding flight."

Having thus described our invention, what we claim is—

1. In a bee-hive, the combination with the super-section of strips or separators located between the sections and provided with spurs or projections, substantially as described.

2. In a bee-hive the combination with the super sections, of the separators provided with spurs or projections adapted to indent and support the sections, the casing composed of detachable sides and the tension rods which pass through apertures formed in the extremities of two sides and engage lugs or projec-

tions formed on the other two sides the rods being provided with suitable nuts which they are threaded to receive, whereby the super may be simultaneously compressed on all 5 sides, substantially as described.

3. In a bee hive the combination with the super sections and the knock-down casing, of the separator provided with spurs or projections adapted to indent and support the sections as the sides are compressed, and means for compressing the sides, substantially as described. 10

4. In a bee-hive the combination with the super sections and the knock down casing in-

closing the same, of strips or separators located between the sections and carrying projecting spurs or edges adapted to indent the sections as the casing is compressed, and tension rods engaging the casing whereby it is simultaneously compressed on all sides, substantially as described. 15 20

In testimony whereof we affix our signatures in presence of two witnesses.

ROBERT C. AIKIN.

HARRY KNIGHT.

Witnesses:

WM. MCCONNELL,

H. J. HOWZE.