

H. C. HARTMAN.
 HONEYCOMB FRAME.
 APPLICATION FILED FEB. 18, 1921.

1,411,094.

Patented Mar. 28, 1922.

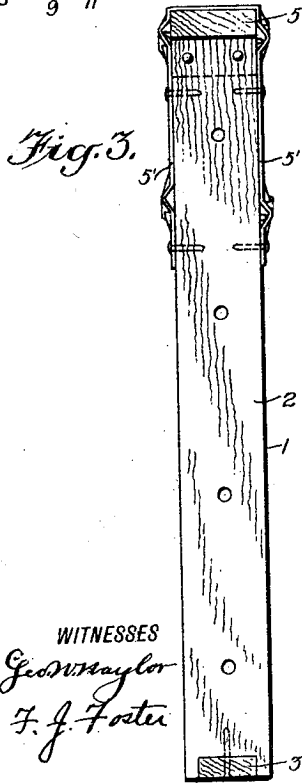
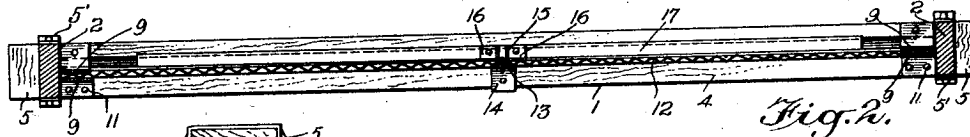
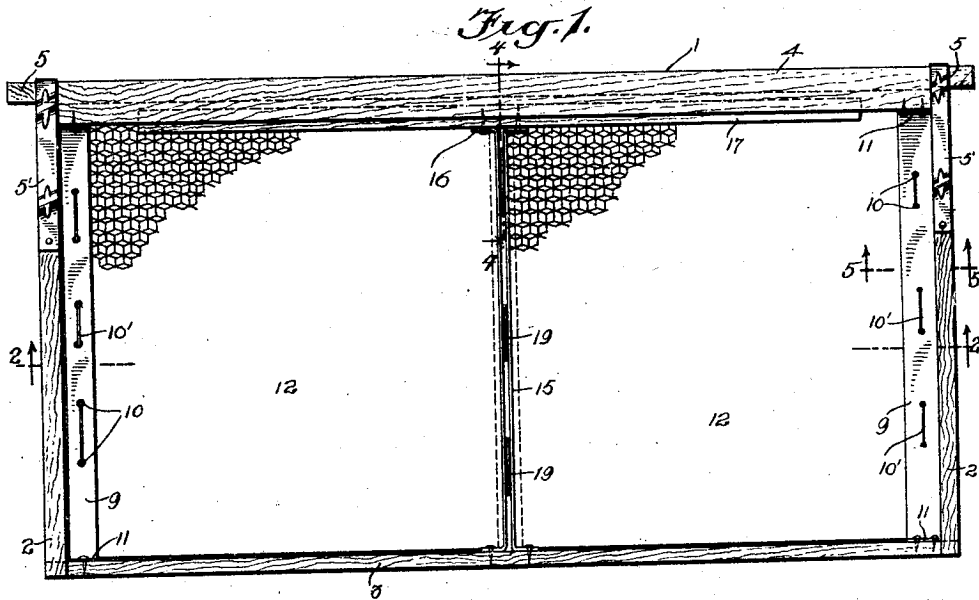

Fig. 3.

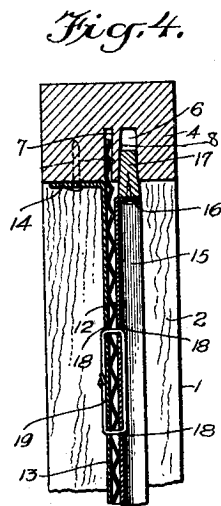

Fig. 4.

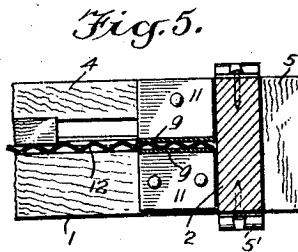

Fig. 5.

WITNESSES
George Taylor
F. J. Foster

INVENTOR
 HARRY C. HARTMAN
 BY *Mumilo*
 ATTORNEYS

H. C. HARTMAN.
 HONEYCOMB FRAME.
 APPLICATION FILED FEB. 18, 1921.

1,411,094.

Patented Mar. 28, 1922.

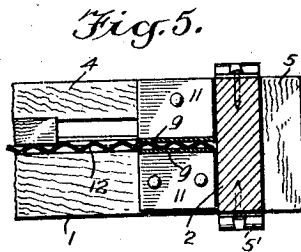
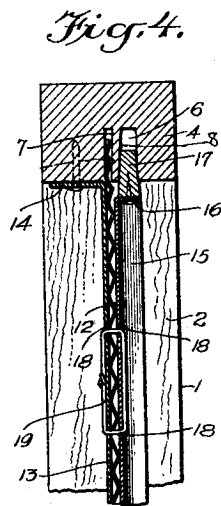
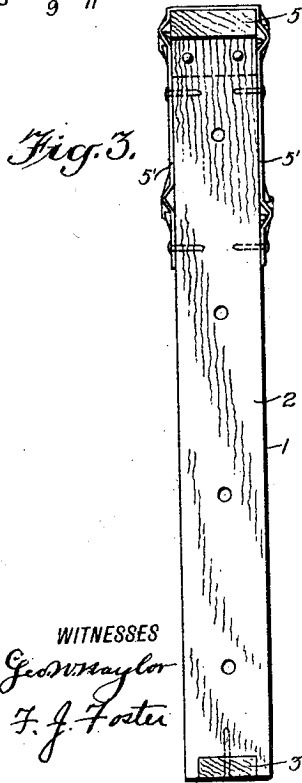
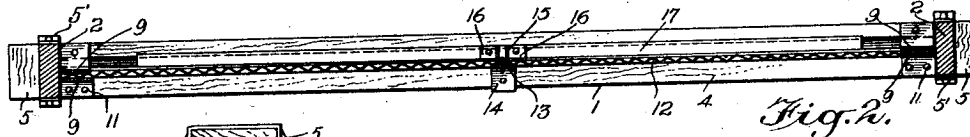
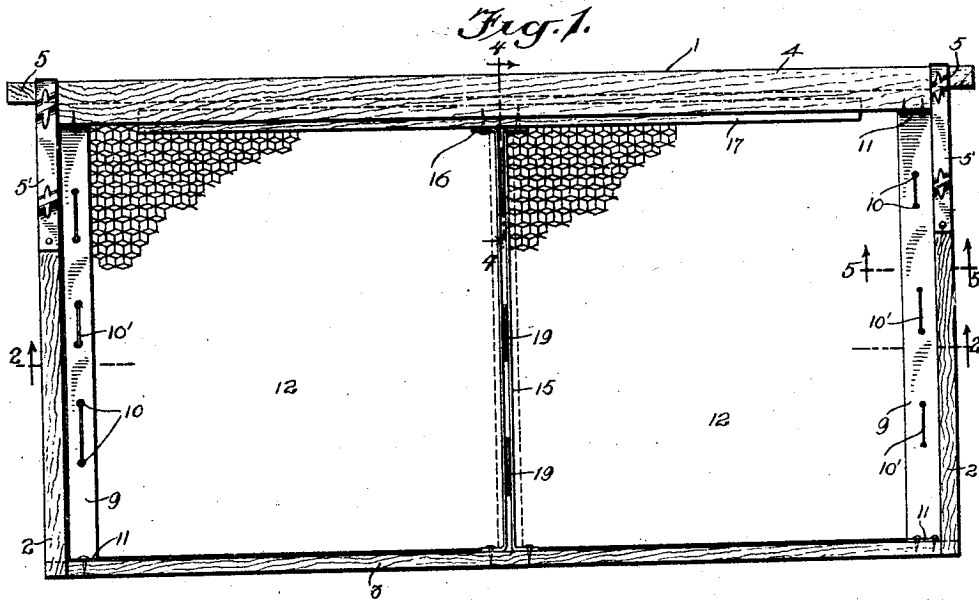

WITNESSES
George Taylor
F. J. Foster

INVENTOR
 HARRY C. HARTMAN
 BY *Mumford*
 ATTORNEYS

H. C. HARTMAN.
 HONEYCOMB FRAME.
 APPLICATION FILED FEB. 18, 1921.

1,411,094.

Patented Mar. 28, 1922.

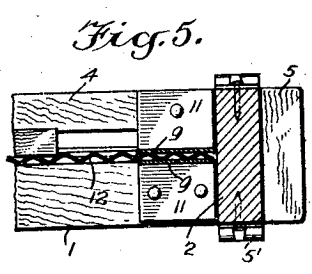
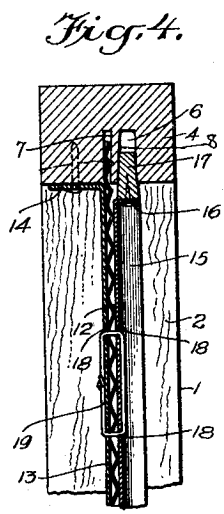
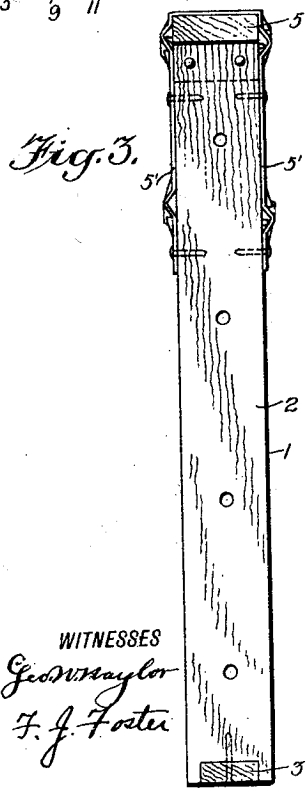
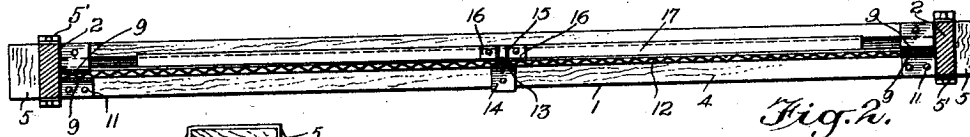
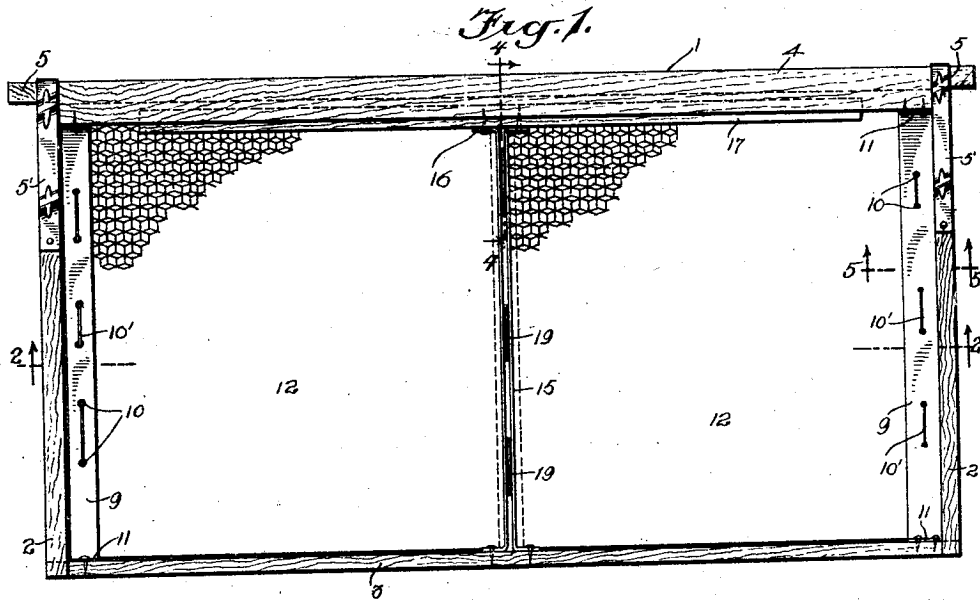

WITNESSES
George Taylor
F. J. Foster

INVENTOR
 HARRY C. HARTMAN
 BY *Mumilo*
 ATTORNEYS